

6.1

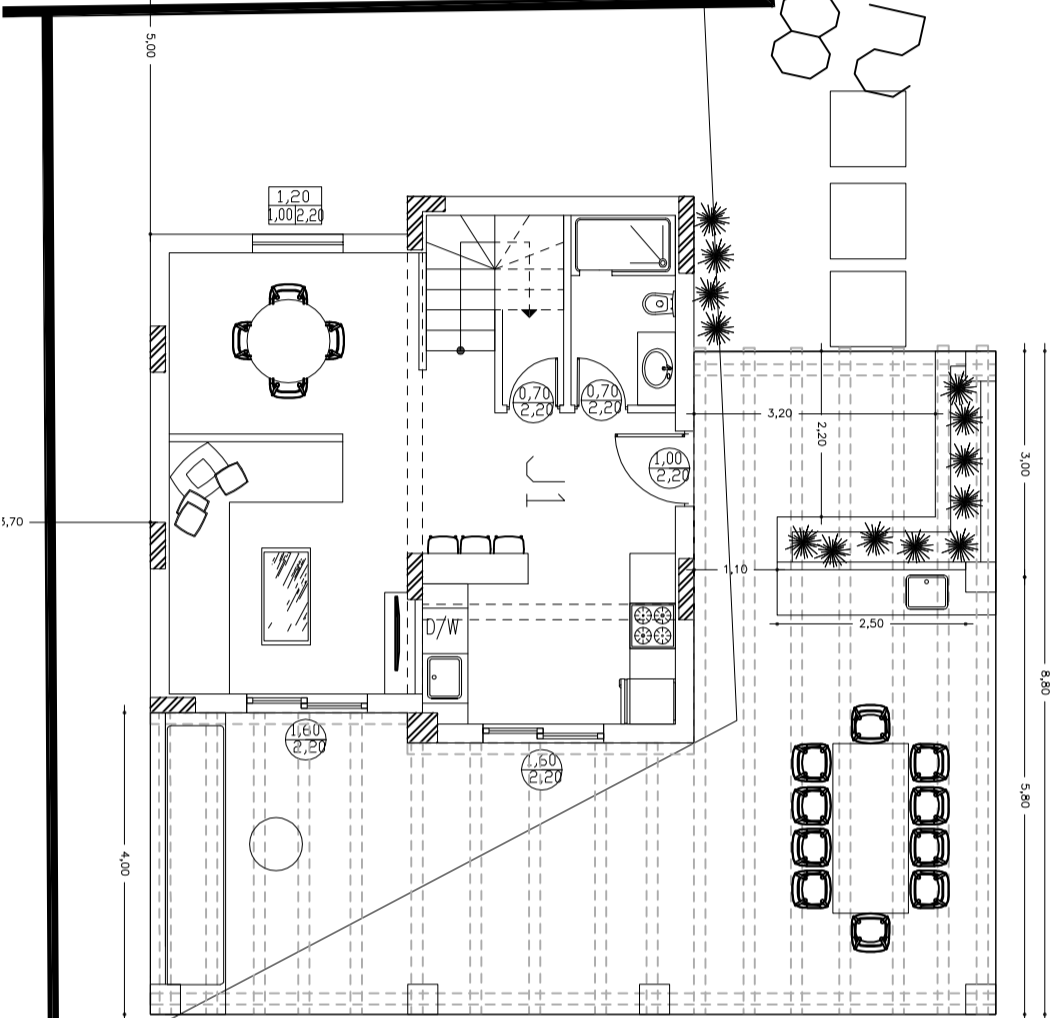

10,00

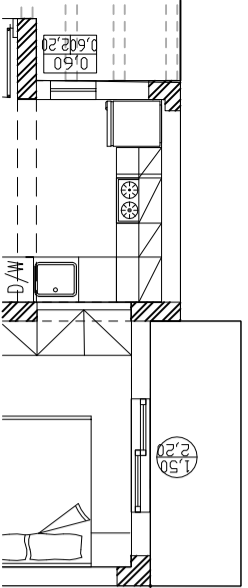
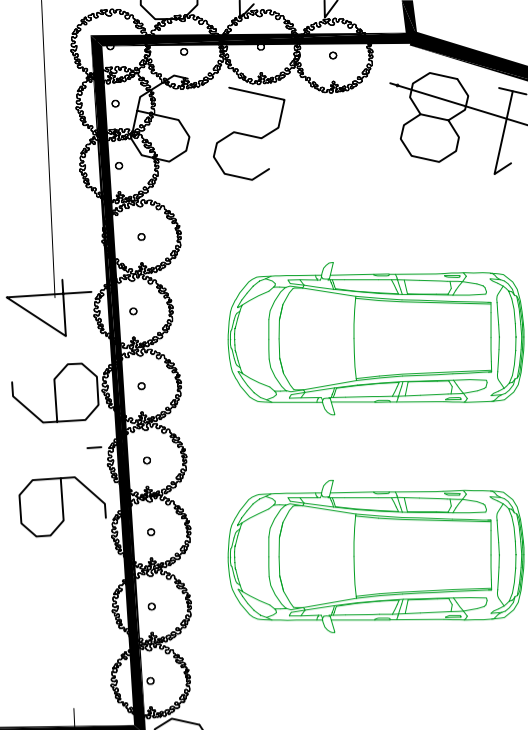

3,60 3,08 4,52 11,20

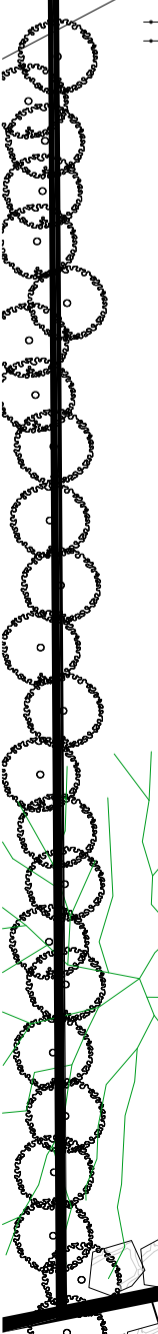

LAND 31

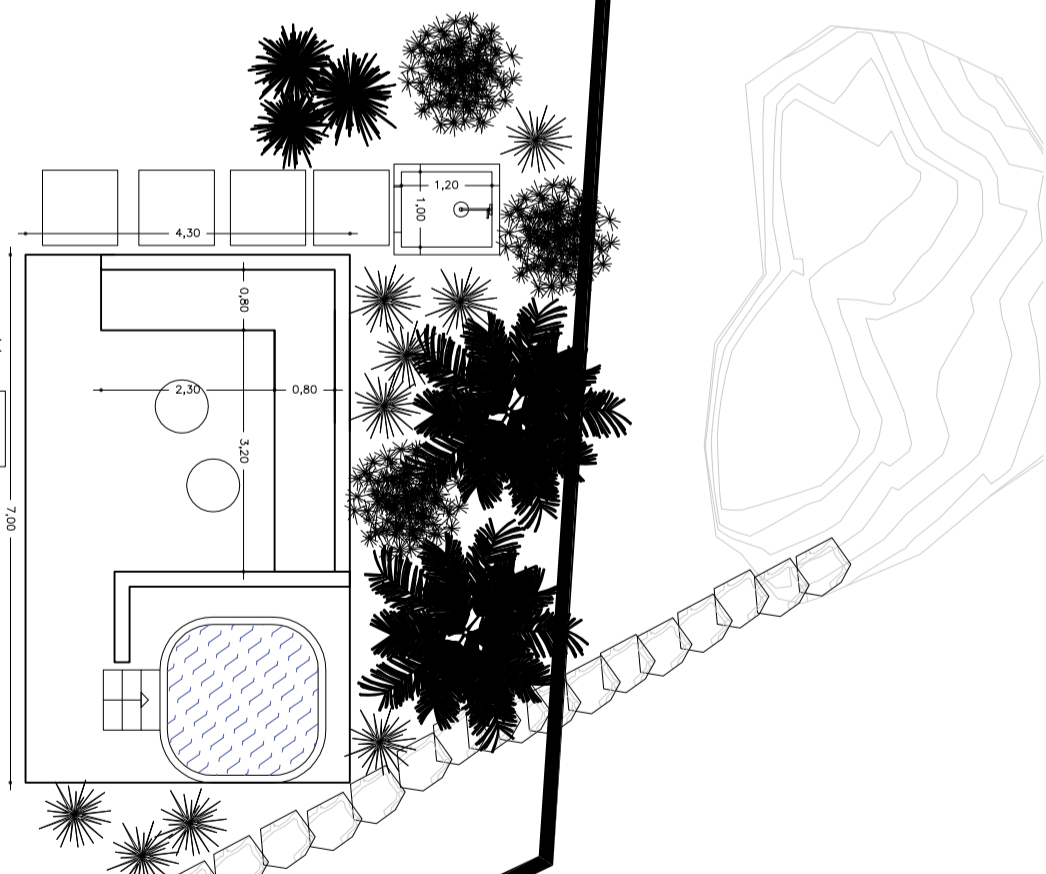
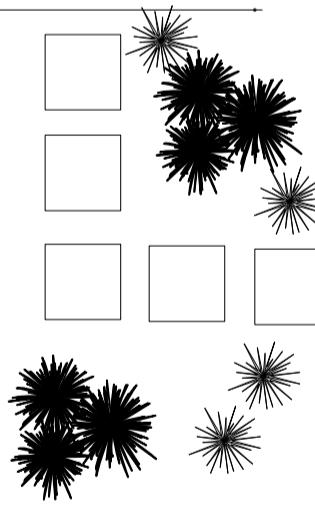

7,00

4,30 1,20 1,00

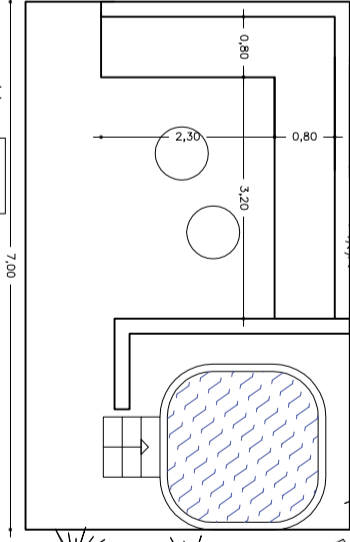

0,80 0,80 2,30 3,20

